

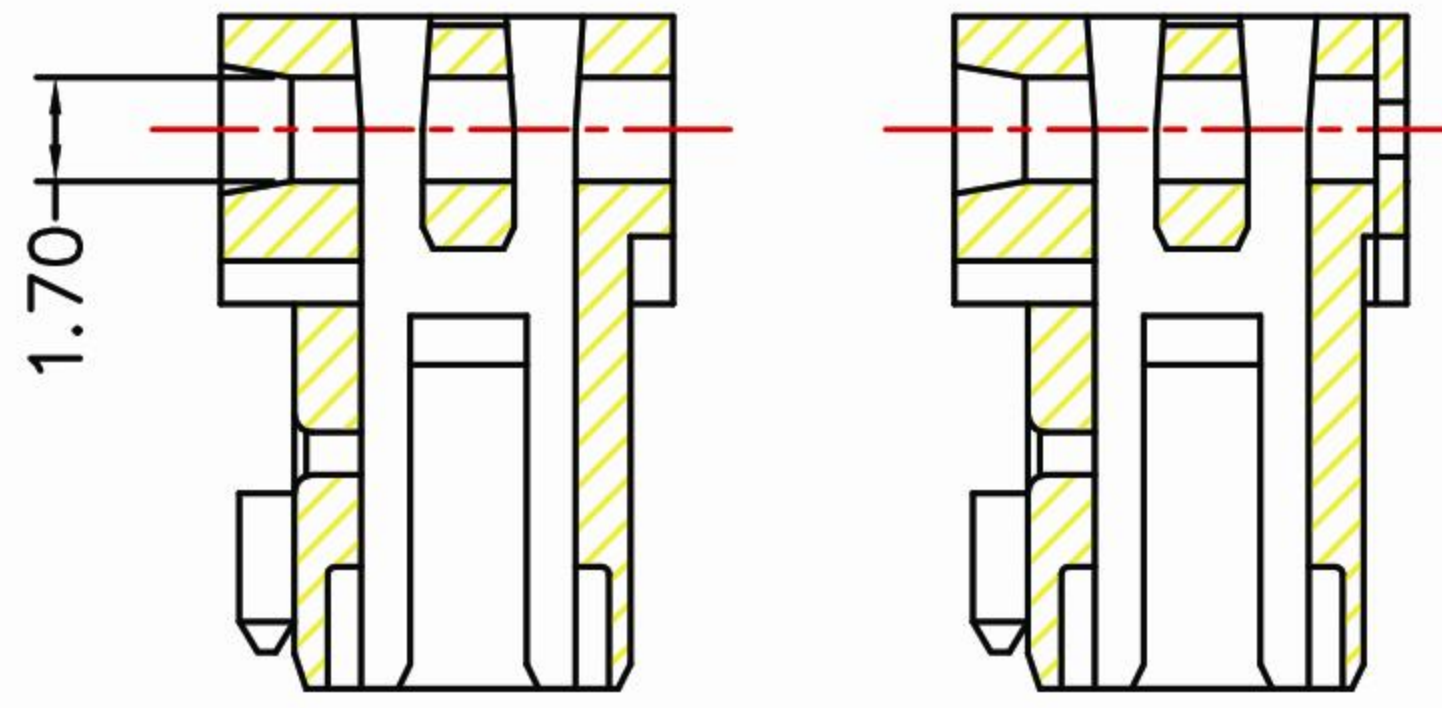

M7235 M7235R

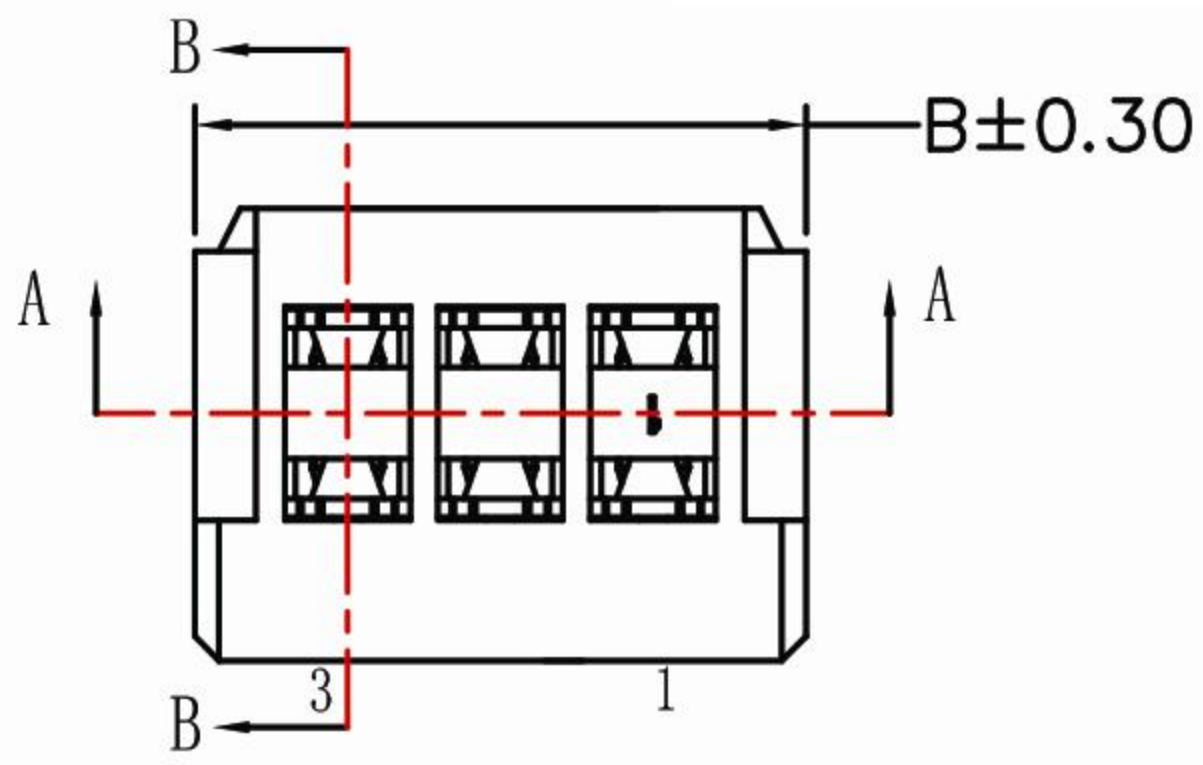

SECTION: B-B

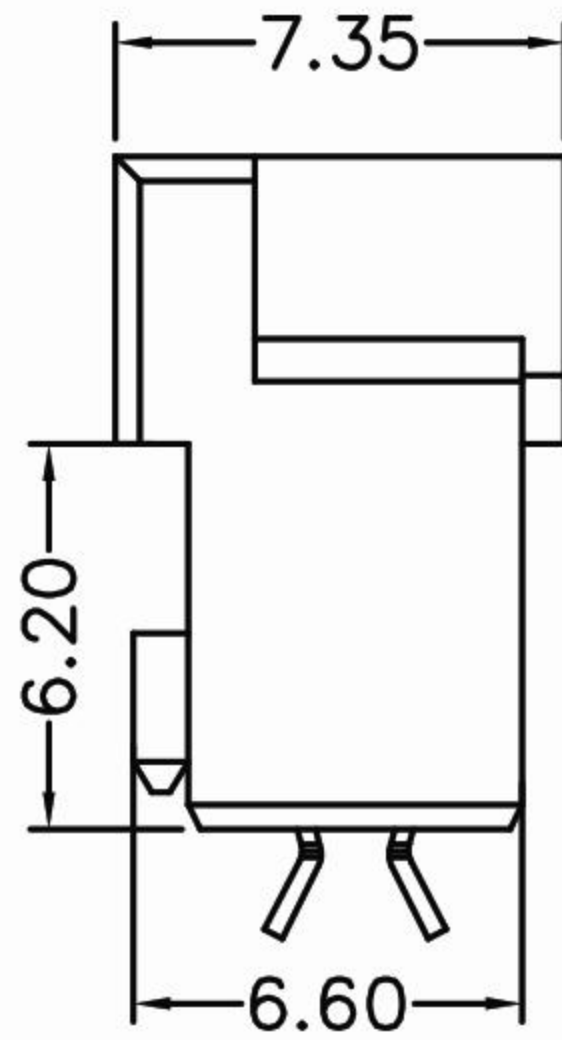
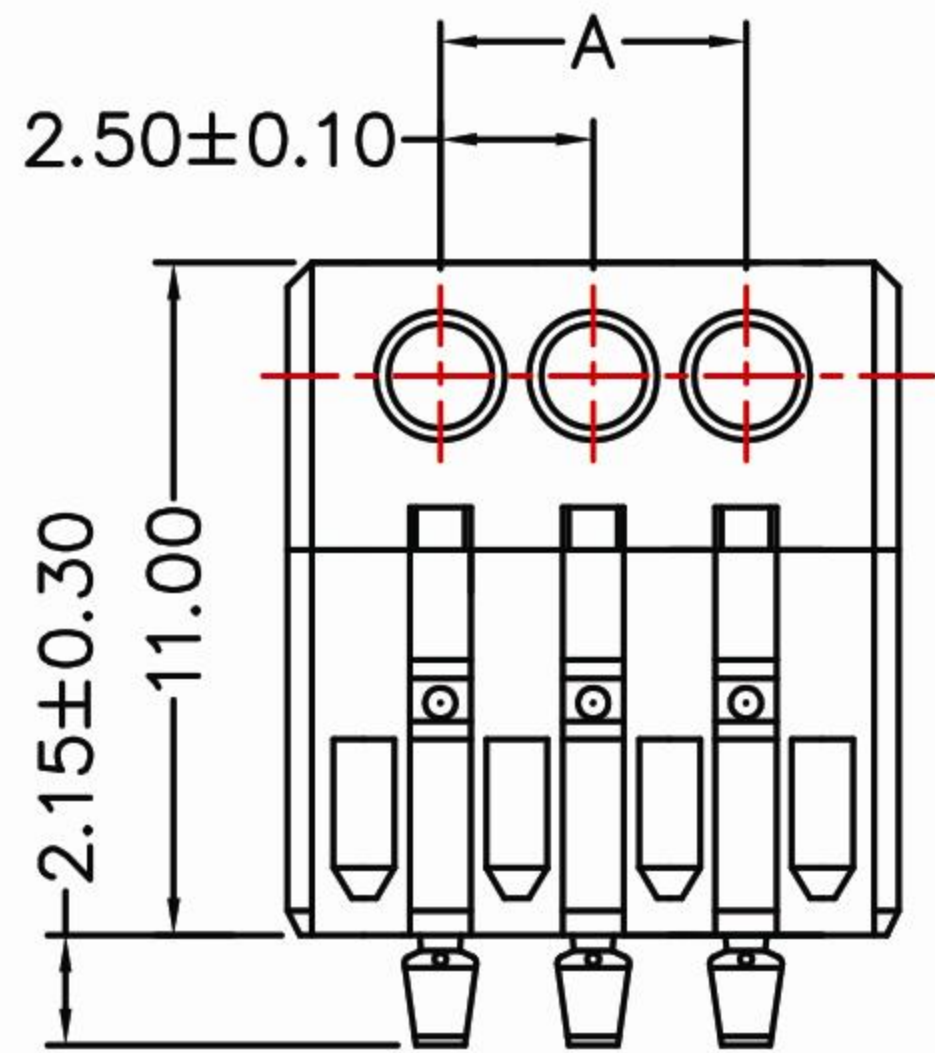

SPECIFICATION

Current rating: 3AAC, DC
 Voltage rating: 32V AC, DC
 Operating Temperature: -40°C--+120°C
 Contact Resistance: 10mΩ max.
 Insulation resistance: 1000MΩ min.
 Withstanding voltage: 1400V AC/minute
 Material: Housing: Nylon66 UL94V-0
 Terminal: Phosphor bronze, Tin-plated
 Wire range: AWG 24 to 22
 GWT: 750°C IEC-60335-1

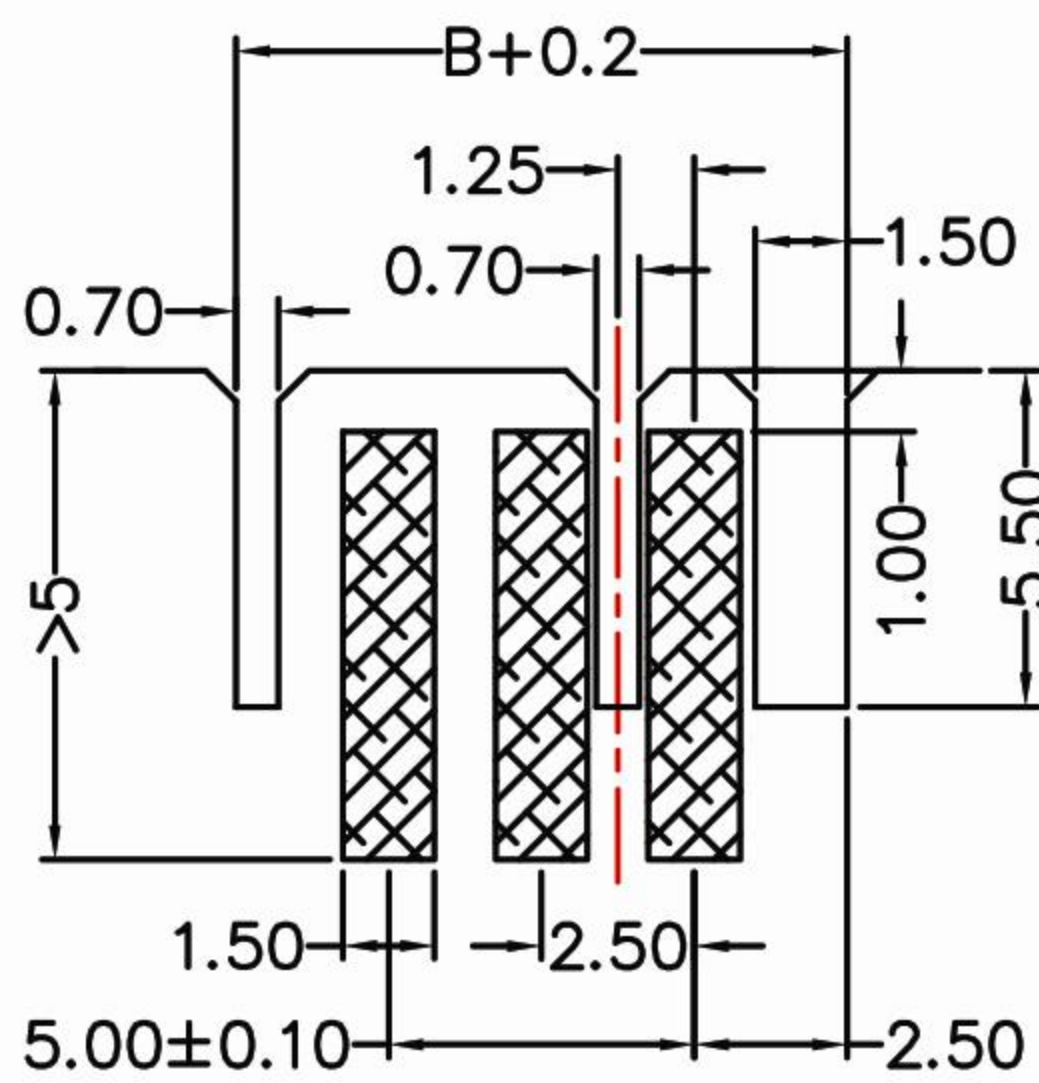
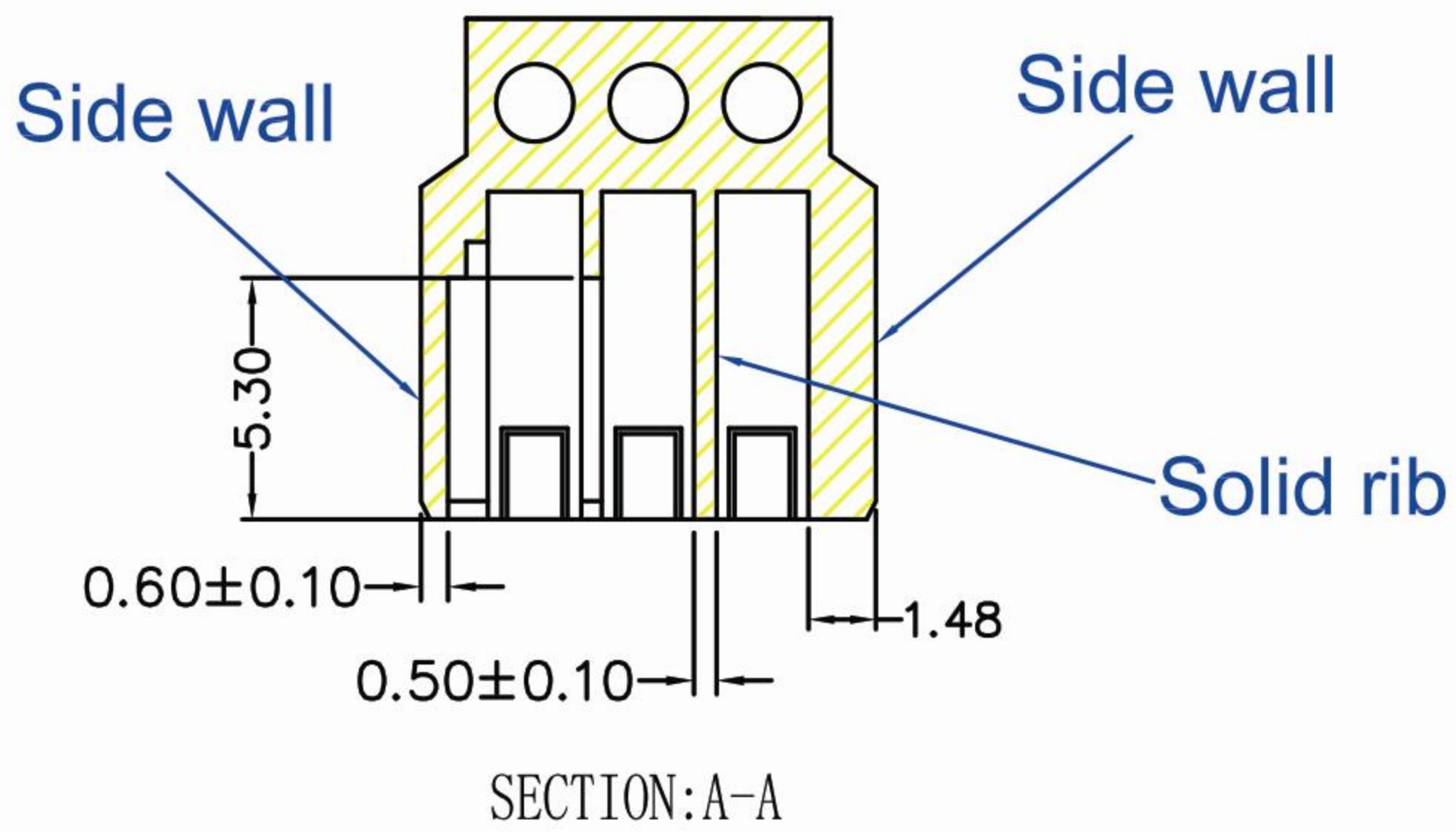

P.C. Board layout

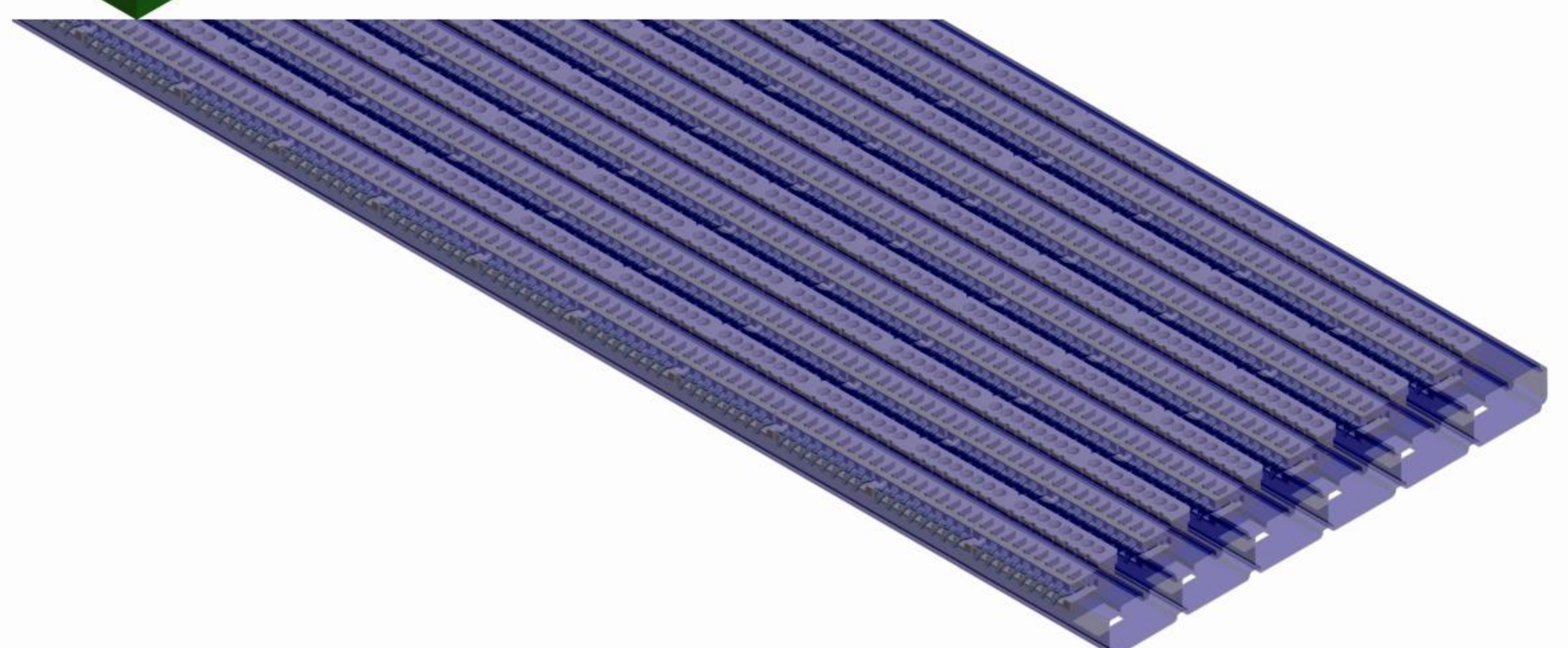
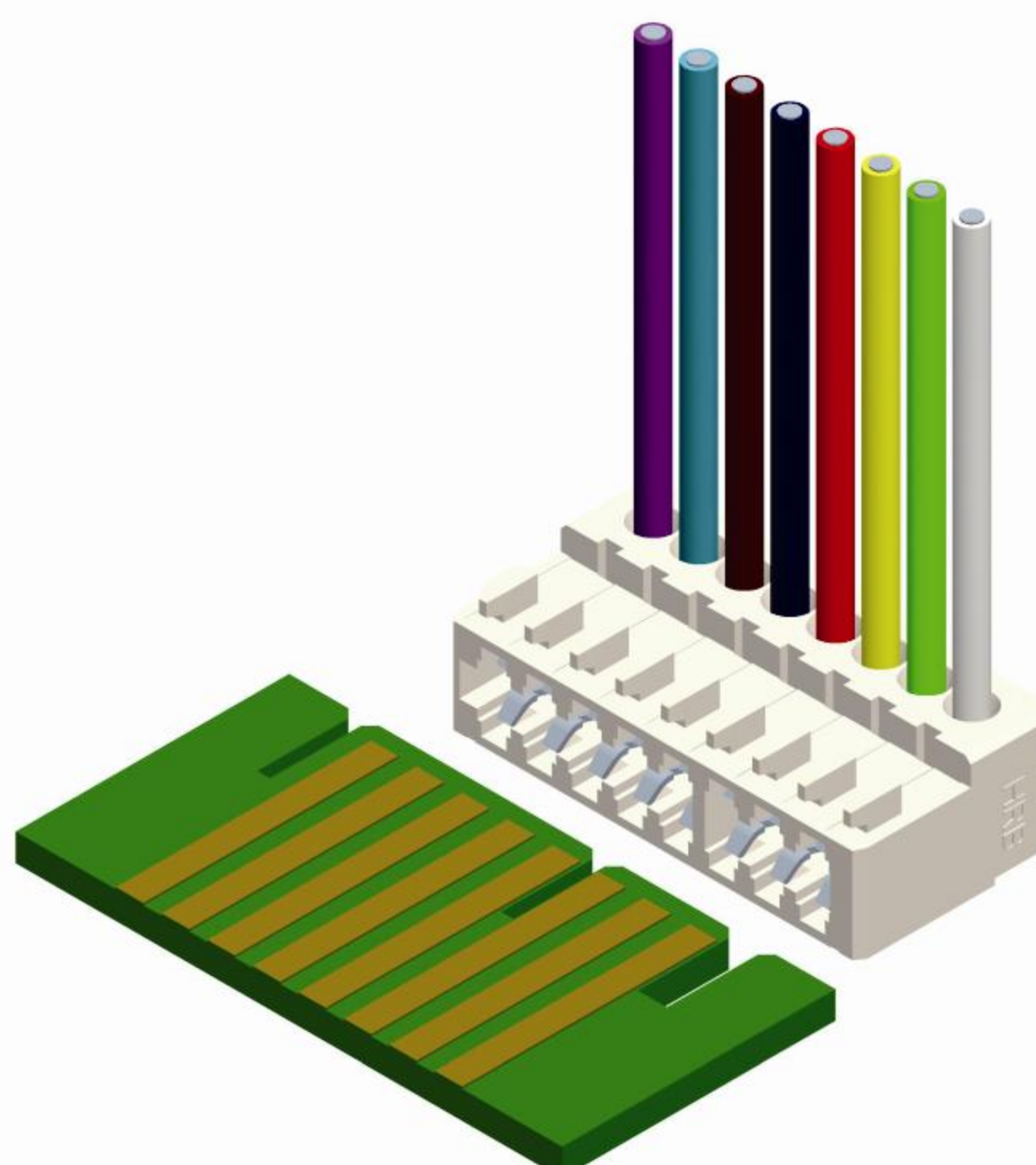

| Dimension | | |
|-------------|------|------|
| Circuit No. | A | B |
| 2 | 2.5 | 7.5 |
| 3 | 5.0 | 10.0 |
| 4 | 7.5 | 12.5 |
| 5 | 10.0 | 15.0 |
| 6 | 12.5 | 17.5 |
| 7 | 15.0 | 20.0 |
| 8 | 17.5 | 22.5 |
| 9 | 20.0 | 25.0 |
| 10 | 22.5 | 27.5 |
| 11 | 25.0 | 30.0 |
| 12 | 27.5 | 32.5 |
| 13 | 30.0 | 35.0 |
| 14 | 32.5 | 37.5 |
| 15 | 35.0 | 40.0 |
| 16 | 37.5 | 42.5 |
| 17 | 40.0 | 45.0 |
| 18 | 42.5 | 47.5 |
| 19 | 45.0 | 50.0 |
| 20 | 47.5 | 52.5 |



M7235 Series coding chart

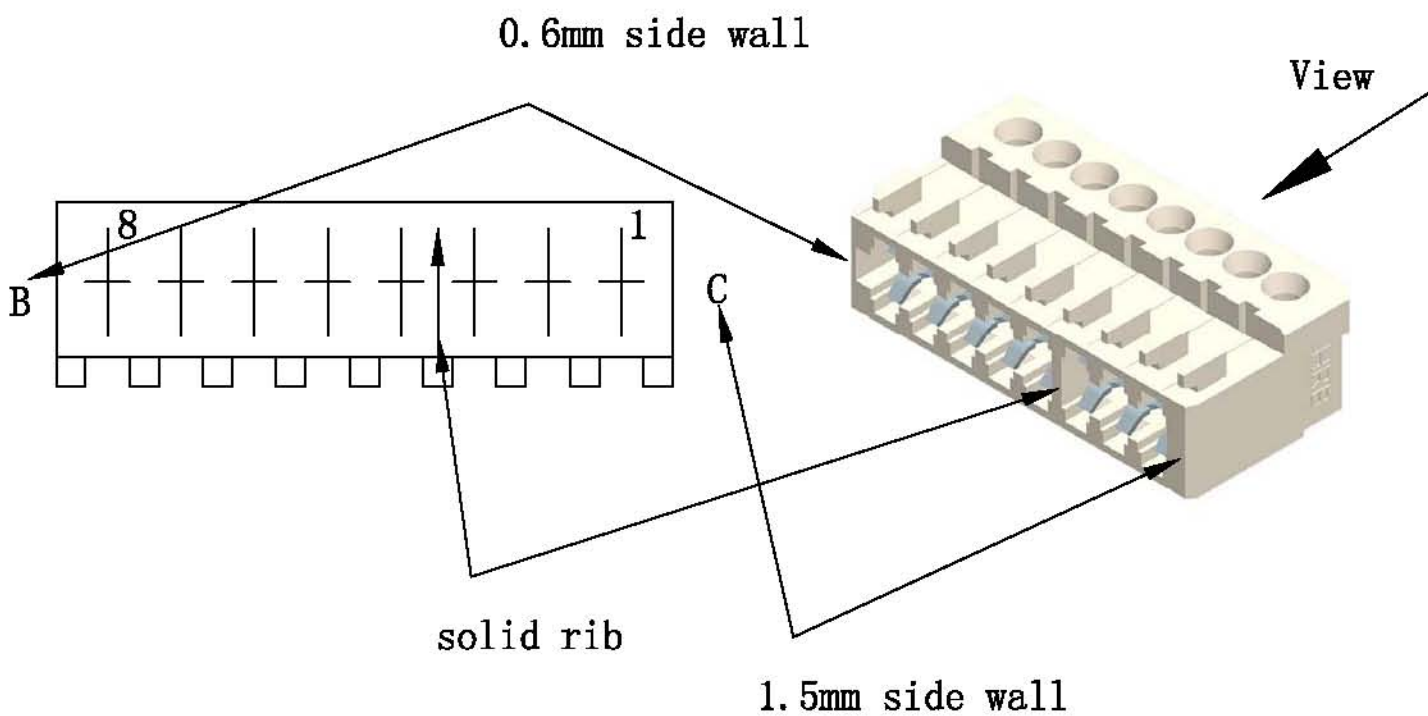
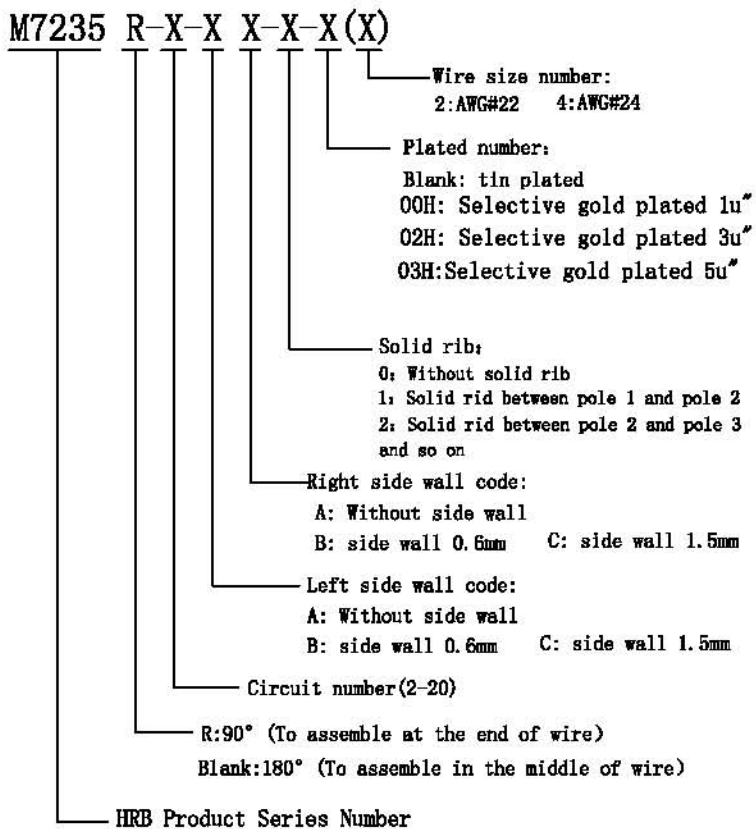

The following part numbers are the ones that have been producing in HRB. Of course, we can adjust the fool-proof positions and circuits of product to define some new part numbers and produce.

You're welcome to choose our product!

3 Circuits

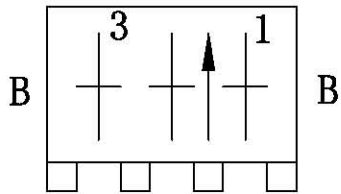

M7235-3-BB-1 (2)

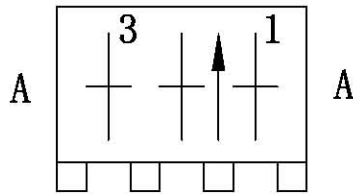

M7235-3-AA-1 (2)

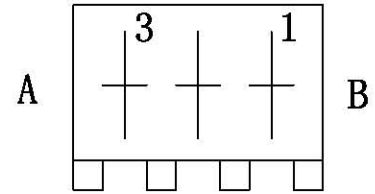

M7235-3-AB-0 (2)

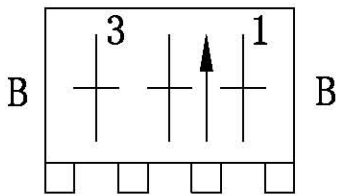

M7235-3-BB-1 (4)

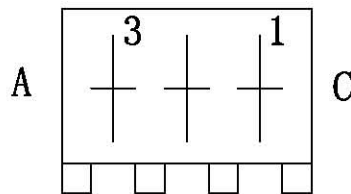

M7235-3-AC-0 (2)

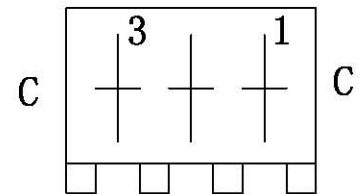

M7235-3-CC-0 (2)

5 Circuits

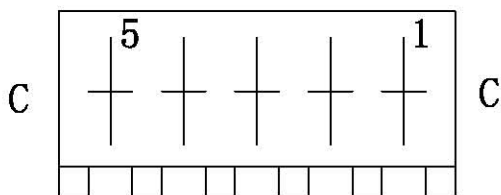

M7235-5-CC-0 (2)

6 Circuits

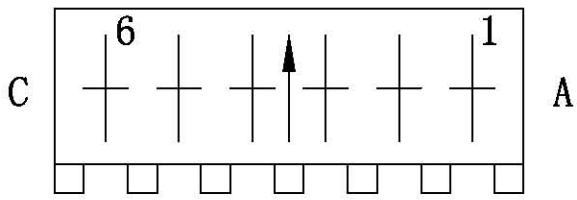

M7235R-6-CA-0(4)

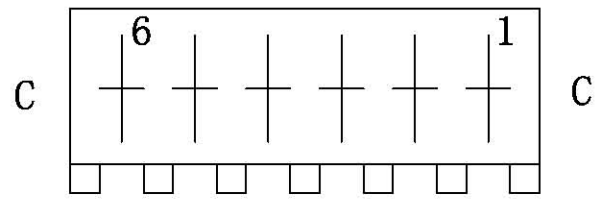

M7235-6-CC-0(2)

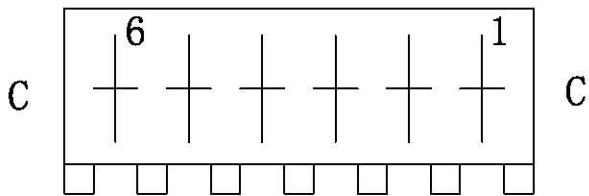

M7235-6-CC-0-02H(2)

7 Circuits

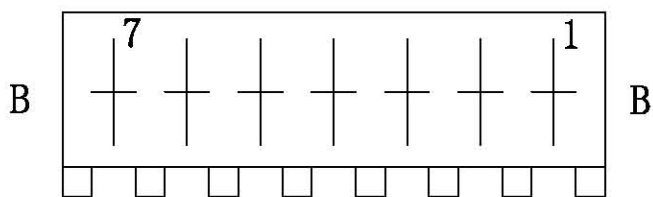

M7235R-7-BB-0(2)

8 Circuits

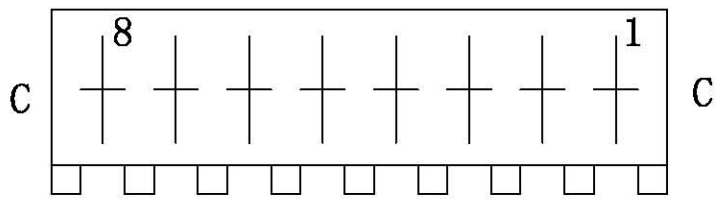

M7235-8-CC-0(2)

9 Circuits

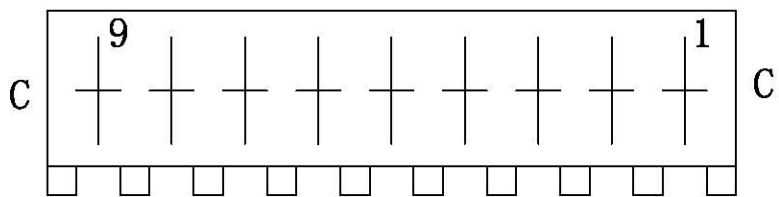

M7235-9-CC-0(2)

17 Circuits

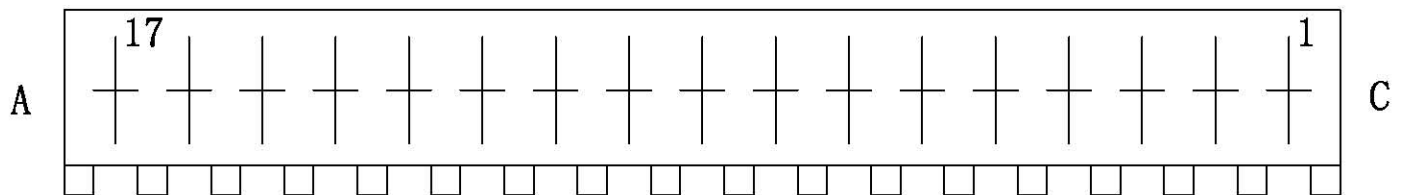

M7235R-17-AC-0(4)